

10 SERIES-WATERPROOF BOX

10 series waterproof boxes are small to medium in size and offer cost effective solutions for many applications.



FEATURES

- *Material: ABS, AS(for clear lid)*
- *Temperature range: -20°C ~ 60°C*
- *Flammability rating: UL94HB*
- *Most of 10 series boxes meet IP65 of IEC 60529 dustproof and waterproof requirement*
- *A wide range of size*
- *Designed for mounting P.C.B. or DIN rail mounted terminal*
- *Transparent lid is available for most models*
- *Wall mounting holes and lid attaching screws are outside the sealing area*
- *Custom material and color available (Bone as standard color)*
- *Standard delivery: 1 box, 1 lid, 4 or 6 screws, 1 Seal*











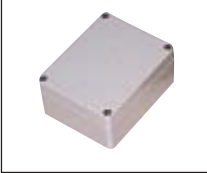

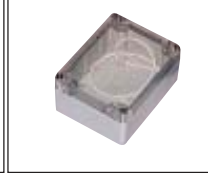



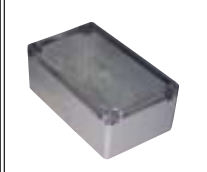

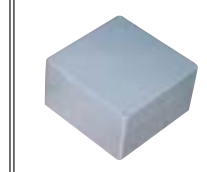
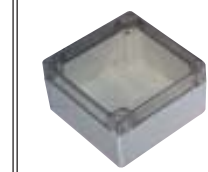









NOTE

1. *Optional accessories should be ordered separately.*
2. *We can accept customization of mold on condition that you undertake the cost of the mold*
3. *For the bigger order(Over 500 pieces), material of ROHS or UL94-V0 is available.*
4. *A little difference of colors maybe exist for different order, but we make it similar as possible as we can.*

10 Sealed plastic enclosure

Plastic junction box

| | | | | | |
|---|--|---|--|--|--|
|  10-1:115x90x55 |  10-1-1:115x90x70 |  10-2:115x90x55 |  10-3:100x68x50 |  10-3-1:100x68x70 |  10-4:100x68x50 |
|  10-5:200x120x75 |  10-6:200x120x75 |  10-7:158x90x60 |  10-8:158x90x60 |  10-9:160x160x90 |  10-10:160x160x90 |
|  10-11:160x160x120 |  10-12:160x160x120 |  10-13:265x185x96 |  10-14:265x185x96 |  10-15:210x160x70-40 |  10-16:210x160x70-40 |
|  10-20:194x80x56 |  10-20-1:194x80x56 |  10-21:120x120x90 |  10-21-1:120x120x90 |  10-22:64x58x35 |  10-23:160x45x55 |
|  10-38:222x145x55 |  10-39:222x145x75 |  10-38-1:222x145x55 10-39-1:222x145x75 |  10-58:120x80x60 |  10-58-1:120x80x60 |  10-59:80x80x55 10-59-1:Clear lid |

| Size | | | Indoor | | Outdoor | |
|-----------|----------|-----------|-----------|-----------|------------|-----------|
| Length/mm | Width/mm | Height/mm | ABS | | PC(PC/ABS) | |
| | | | Solid lid | Clear lid | Solid lid | Clear lid |
| 115 | 90 | 55 | 10-1 | 10-2 | 10-1-PG | 10-2-PT |
| 115 | 90 | 70 | 10-1-1 | 10-1-2 | 10-1-1-PG | 10-1-2-PT |
| 100 | 68 | 50 | 10-3 | 10-4 | 10-3-PG | 10-4-PT |
| 100 | 68 | 70 | 10-3-1 | 10-3-2 | 10-3-1-PG | 10-3-2-PT |
| 200 | 120 | 75 | 10-5 | 10-6 | 10-5-PG | 10-6-PT |
| 158 | 90 | 60 | 10-7 | 10-8 | 10-7-PG | 10-8-PT |
| 160 | 160 | 90 | 10-9 | 10-10 | 10-9-PG | 10-10-PT |
| 160 | 160 | 120 | 10-11 | 10-12 | 10-11-PG | 10-12-PT |
| 265 | 185 | 96 | 10-13 | 10-14 | 10-13-PG | 10-14-PT |

10 Sealed plastic enclosure

| Size | | | Indoor | | Outdoor | |
|-----------|----------|-----------|-----------|-----------|------------|------------|
| Length/mm | Width/mm | Height/mm | ABS | | PC(PC/ABS) | |
| | | | Solid lid | Clear lid | Solid lid | Clear lid |
| 210 | 160 | 70-40 | 10-15 | 10-16 | 10-15-PG | 10-16-PT |
| 194 | 80 | 56 | 10-20 | 10-20-1 | 10-20-PG | 10-20-1-PT |
| 120 | 120 | 90 | 10-21 | 10-21-1 | 10-21-PG | 10-21-1-PT |
| 64 | 58 | 35 | 10-22 | 10-22-1 | 10-22-PG | 10-22-1-PT |
| 160 | 45 | 55 | 10-23 | 10-23-1 | 10-23-PG | 10-23-1-PT |
| 222 | 145 | 55 | 10-38 | 10-38-1 | 10-38-PG | 10-38-1-PT |
| 222 | 145 | 75 | 10-39 | 10-39-1 | 10-39-PG | 10-39-1-PT |
| 120 | 80 | 60 | 10-58 | 10-58-1 | 10-58-PG | 10-58-1-PT |
| 80 | 80 | 55 | 10-59 | 10-59-1 | 10-59-PG | 10-59-1-PT |

Assembly drawing for plastic junction box

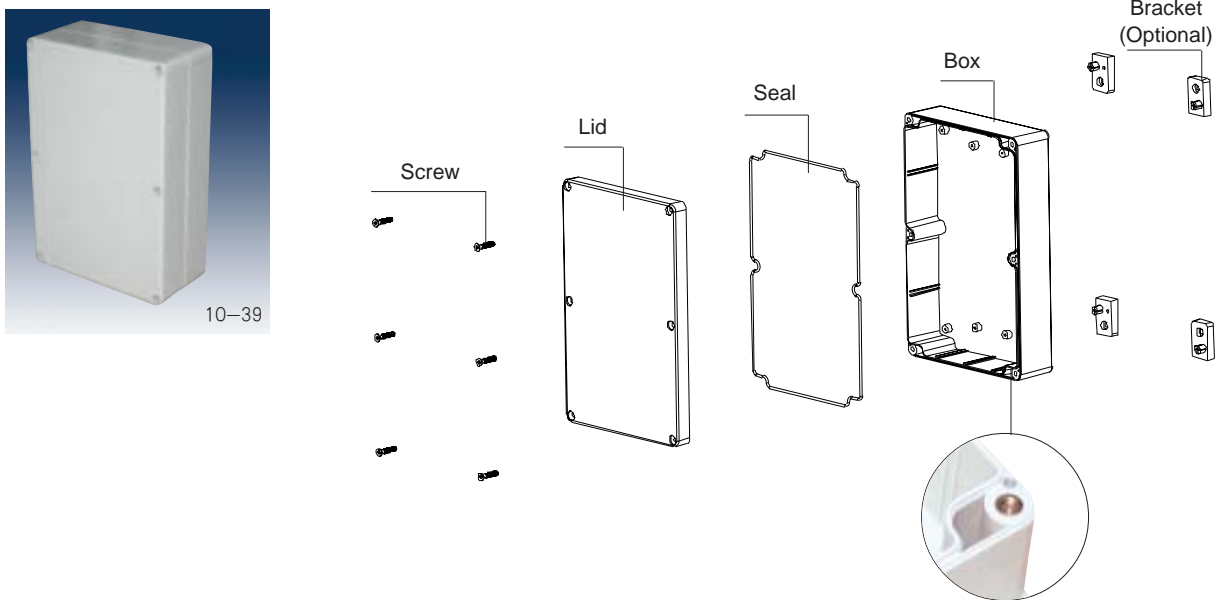

Unit: mm

| | T1 | T2 | T3 | T4 | L1 | L2 | L3 | L4 | H1 | H2 |
|---------|-----|-----|-------|-------|-----|-----|------|------|---------|-------|
| 10-1 | 115 | 109 | 102.5 | 77 | 90 | 84 | 77.5 | 68 | 15 | 40 |
| 10-1-1 | 115 | 109 | 102.5 | 77 | 90 | 84 | 77.5 | 68 | 15 | 55 |
| 10-2 | 115 | 109 | 102.5 | 77 | 90 | 84 | 77.5 | 68 | 15 | 40 |
| 10-3 | 100 | 92 | 87.5 | 80 | 68 | 60 | 56 | 46 | 15 | 35 |
| 10-3-1 | 100 | 92 | 87.5 | 80 | 68 | 60 | 56 | 46 | 15 | 57 |
| 10-4 | 100 | 92 | 87.5 | 80 | 68 | 60 | 56 | 46 | 15 | 35 |
| 10-5 | 200 | 194 | 188 | 160 | 120 | 114 | 108 | 92 | 15 | 60 |
| 10-6 | 200 | 194 | 188 | 160 | 120 | 114 | 108 | 92 | 15 | 60 |
| 10-7 | 158 | 152 | 148 | 140 | 90 | 84 | 79 | 48.5 | 20 | 40 |
| 10-8 | 158 | 152 | 148 | 140 | 90 | 84 | 79 | 48.5 | 20 | 40 |
| 10-9 | 160 | 154 | 146 | 137.5 | 160 | 154 | 146 | 95 | 30 | 60 |
| 10-10 | 160 | 154 | 146 | 137.5 | 160 | 154 | 146 | 95 | 30 | 60 |
| 10-11 | 160 | 154 | 146 | 137.5 | 160 | 154 | 146 | 95 | 30 | 90 |
| 10-12 | 160 | 154 | 146 | 137.5 | 160 | 154 | 146 | 95 | 30 | 90 |
| 10-13 | 265 | 259 | 253 | 245 | 185 | 179 | 173 | 165 | 21 | 75 |
| 10-14 | 265 | 259 | 253 | 245 | 185 | 179 | 173 | 165 | 21 | 75 |
| 10-15 | 210 | 204 | - | - | 160 | 154 | - | - | 28-15.5 | 41-25 |
| 10-16 | 210 | 204 | - | - | 160 | 154 | - | - | 28-15.5 | 41-25 |
| 10-20 | 194 | 189 | 184 | 160 | 80 | 74 | 68 | 45 | 10.5 | 45.5 |
| 10-20-1 | 195 | 187 | 184 | 160 | 80 | 74 | 68 | 45 | 10.5 | 45.5 |
| 10-21 | 120 | 114 | 105 | 56 | 120 | 114 | 105 | 98 | 30 | 60 |

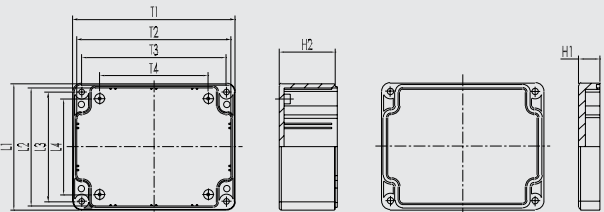

Unit: mm

| | T1 | T2 | T3 | T4 | L1 | L2 | L3 | L4 | H1 | H2 |
|---------|-----|------|-------|------|-----|------|-------|-----|----|----|
| 10-21-1 | 120 | 114 | 105 | 56 | 120 | 114 | 105 | 98 | 30 | 60 |
| 10-22 | 64 | 57.5 | 52 | 20 | 58 | 51.5 | 46 | - | 10 | 25 |
| 10-23 | 160 | 155 | 151 | 143 | 45 | 39 | 37 | 20 | 15 | 40 |
| 10-38 | 222 | 216 | 210 | 182 | 145 | 139 | 134 | 116 | 15 | 40 |
| 10-38-1 | 222 | 216 | 210 | 182 | 145 | 139 | 134 | 116 | 15 | 40 |
| 10-39 | 222 | 216 | 210 | 182 | 145 | 139 | 134.5 | 116 | 35 | 40 |
| 10-39-1 | 222 | 216 | 210 | 182 | 145 | 139 | 134.5 | 116 | 35 | 40 |
| 10-58 | 120 | 114 | 108.5 | 82 | 80 | 74 | 69 | 59 | 20 | 40 |
| 10-58-1 | 120 | 114 | 108.5 | 82 | 80 | 74 | 69 | 59 | 20 | 40 |
| 10-59 | 80 | 76 | 44 | 70.5 | 80 | 74 | 70.5 | 60 | 16 | 39 |
| 10-59-1 | 80 | 76 | 44 | 70.5 | 80 | 74 | 70.5 | 60 | 16 | 39 |

Plastic terminal block box

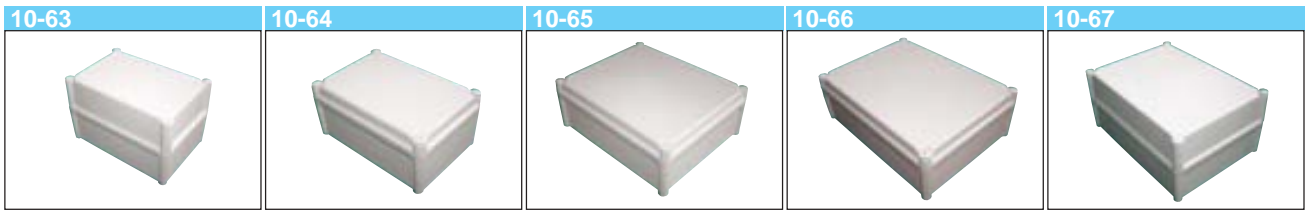

10-63:280x190x180
10-63-1:clear lid

10-64:280x190x130
10-64-1:clear lid

10-65:340x280x130
10-65-1:clear lid

10-66:380x280x130
10-66-1:clear lid

10-67:380x280x180
10-67-1:clear lid

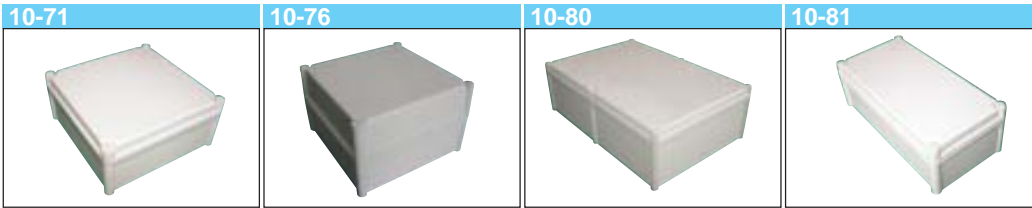

10-71:280x280x130
10-71-1:clear lid

10-76:280x280x180
10-76-1:clear lid

10-80:550x380x180
10-80-1:clear lid

10-81:380x190x130
10-81-1:clear lid

| Size | | | Indoor | | Outdoor | |
|-----------|----------|-----------|-----------|-----------|------------|------------|
| Length/mm | Width/mm | Height/mm | ABS | | PC(PC/ABS) | |
| | | | Solid lid | Clear lid | Solid lid | Clear lid |
| 280 | 190 | 180 | 10-63 | 10-63-1 | 10-63-PG | 10-63-1-PT |
| 280 | 190 | 130 | 10-64 | 10-64-1 | 10-64-PG | 10-64-1-PT |
| 280 | 340 | 130 | 10-65 | 10-65-1 | 10-65-PG | 10-65-1-PT |
| 280 | 380 | 130 | 10-66 | 10-66-1 | 10-66-PG | 10-66-1-PT |
| 280 | 380 | 180 | 10-67 | 10-67-1 | 10-67-PG | 10-67-1-PT |

Assembly drawing for plastic terminal block box

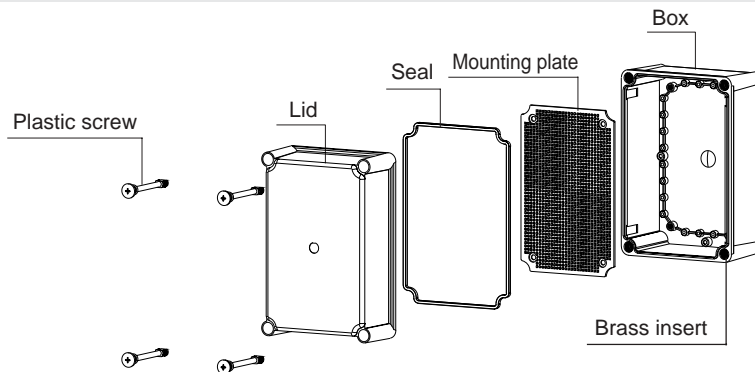

Unit:mm

| | T1 | T2 | T3 | T4 | L1 | L2 | L3 | L4 | H1 | H2 |
|-------|-----|-----|-----|-----|-----|-----|-----|-----|----|-----|
| 10-63 | 280 | 268 | 241 | 249 | 190 | 174 | 151 | 153 | 80 | 100 |
| 10-64 | 280 | 272 | 255 | 250 | 190 | 176 | 165 | 153 | 30 | 100 |
| 10-65 | 340 | 320 | 316 | 295 | 280 | 260 | 256 | 235 | 30 | 100 |
| 10-66 | 380 | 362 | 355 | 340 | 280 | 262 | 255 | 241 | 30 | 100 |
| 10-67 | 380 | 362 | 355 | 340 | 280 | 262 | 255 | 241 | 80 | 100 |

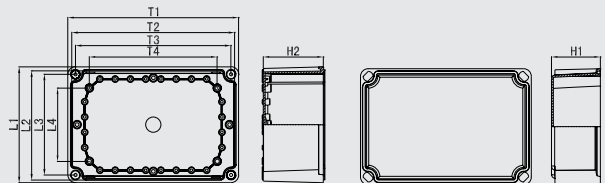

Unit:mm

| | T | L | H |
|-------|-----|-----|---|
| 10-63 | 262 | 168 | 4 |
| 10-64 | 266 | 170 | 4 |
| 10-65 | 314 | 254 | 4 |
| 10-66 | 356 | 256 | 4 |
| 10-67 | 356 | 256 | 4 |



Flanged plastic box

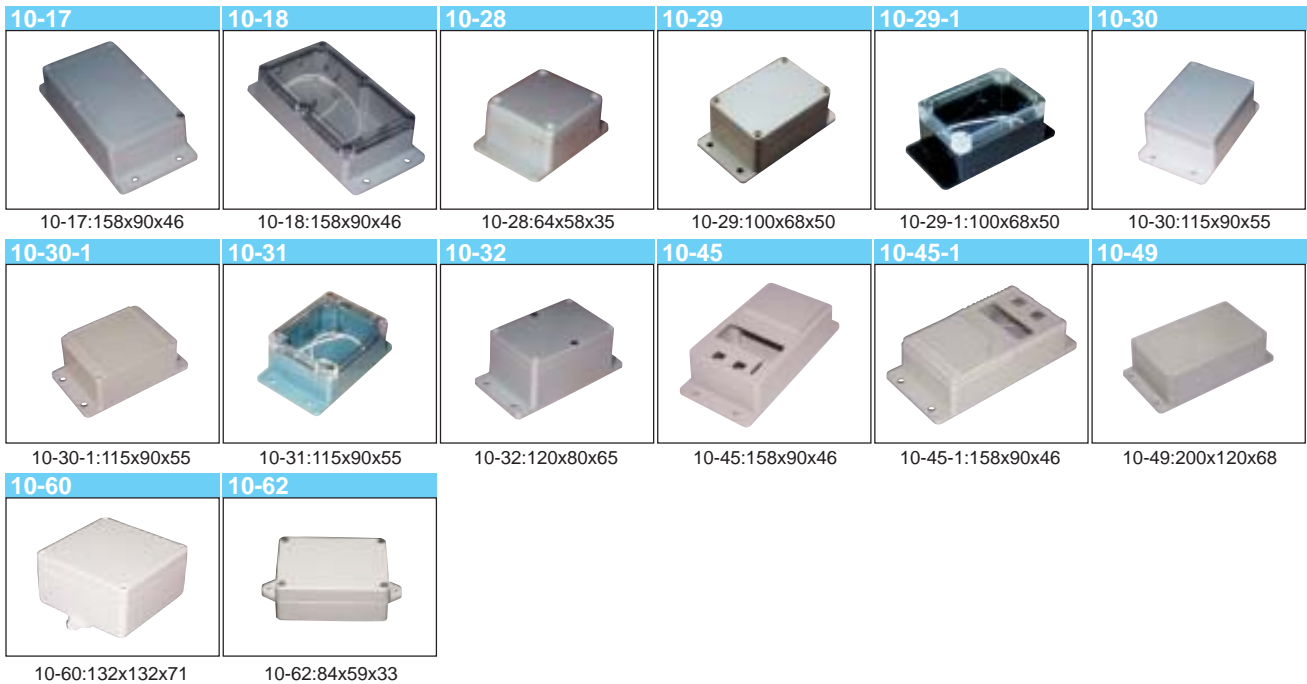

| Size | | | Indoor | | Outdoor | |
|-----------|----------|-----------|-----------|-----------|------------|------------|
| Length/mm | Width/mm | Height/mm | ABS | | PC(PC/ABS) | |
| | | | Solid lid | Clear lid | Solid lid | Clear lid |
| 158 | 90 | 46 | 10-17 | 10-18 | 10-17-PG | 10-18-PT |
| 64 | 58 | 35 | 10-28 | 10-28-1 | 10-28-PG | 10-28-1-PT |
| 100 | 68 | 50 | 10-29 | 10-29-1 | 10-29-PG | 10-29-1-PT |
| 115 | 90 | 55 | 10-30 | 10-31 | 10-30-PG | 10-31-PT |
| 115 | 90 | 55 | 10-30-1 | 10-30-2 | 10-30-1-PG | 10-30-2-PT |
| 120 | 80 | 65 | 10-32 | 10-32-1 | 10-32-PG | 10-32-1-PT |
| 158 | 90 | 46 | 10-45 | 10-45-1 | 10-45-PG | 10-45-1-PT |
| 200 | 120 | 68 | 10-49 | 10-49-1 | 10-49-PG | 10-49-1-PT |
| 132 | 132 | 71 | 10-60 | 10-60-1 | 10-60-PG | 10-60-1-PT |
| 84 | 59 | 33 | 10-62 | 10-62-1 | 10-62-PG | 10-62-1-PT |

Assembly drawing for flanged plastic box

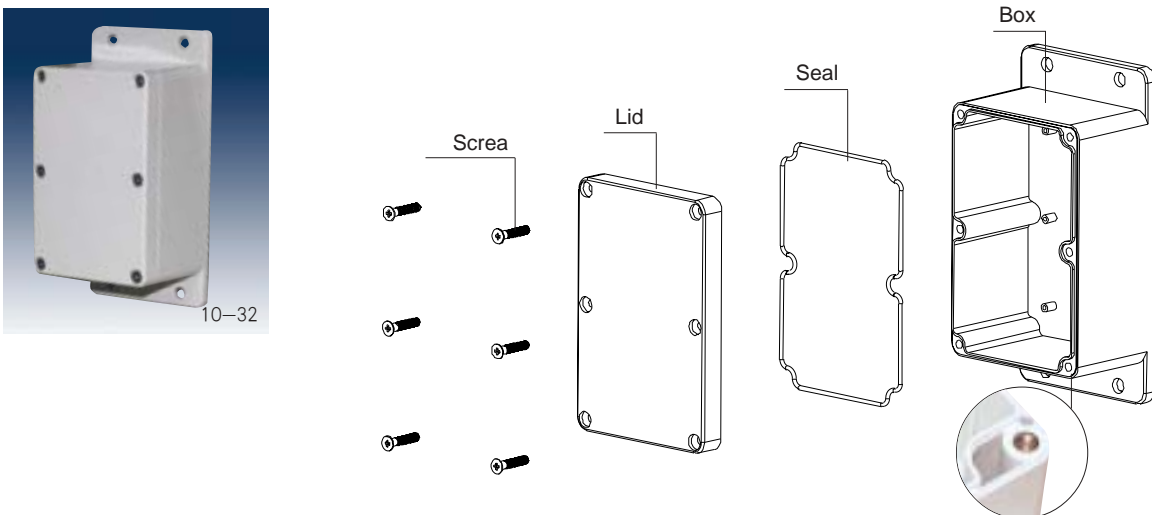

10 Sealed plastic enclosure

| Unit:mm | | | | | | | | | | | |
|---------|-----|-----|------|-------|-----|----|------|------|----|------|------|
| | T1 | T2 | T3 | T4 | T5 | L1 | L2 | L3 | L4 | H1 | H2 |
| 10-17 | 196 | 158 | 151 | 146 | 104 | 90 | 85 | 78 | 50 | 12.5 | 33.5 |
| 10-18 | 196 | 158 | 151 | 146 | 104 | 90 | 85 | 78 | 50 | 12.5 | 33.5 |
| 10-28 | 89 | 64 | 57.5 | 52 | 20 | 58 | 51.5 | 46 | - | 10 | 25 |
| 10-29 | 132 | 100 | 94 | 88 | 46 | 68 | 62 | 56 | 46 | 15 | 35 |
| 10-29-1 | 132 | 100 | 94 | 88 | 46 | 68 | 62 | 56 | 46 | 15 | 35 |
| 10-30 | 153 | 115 | 109 | 102.5 | 77 | 90 | 84 | 77.5 | 68 | 15 | 40 |
| 10-30-1 | 153 | 115 | 109 | 102.5 | 77 | 90 | 84 | 77.5 | 68 | 15 | 40 |
| 10-31 | 153 | 115 | 109 | 102.5 | 77 | 90 | 84 | 77.5 | 68 | 15 | 40 |
| 10-32 | 159 | 120 | 114 | 109 | 84 | 80 | 74 | 69 | 42 | 13 | 52 |
| 10-45 | 196 | 158 | 151 | 146 | 104 | 90 | 85 | 78 | 50 | 11 | 35 |

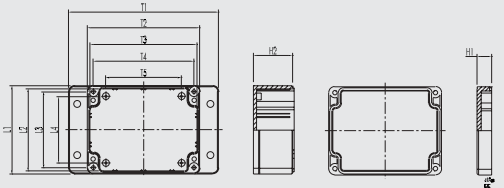

| | T1 | T2 | T3 | T4 | T5 | L1 | L2 | L3 | L4 | H1 | H2 |
|---------|-----|-----|-----|-----|------|-----|-----|-----|----|----|----|
| 10-45-1 | 196 | 158 | 151 | 146 | 104 | 90 | 85 | 78 | 50 | 11 | 35 |
| 10-49 | 239 | 200 | 196 | 188 | 162 | 120 | 116 | 108 | 90 | 15 | 53 |
| 10-60 | 147 | 132 | 124 | 117 | - | 132 | 124 | 117 | - | 15 | 56 |
| 10-62 | 108 | 84 | 77 | 73 | 50.5 | 59 | 52 | 48 | 43 | 12 | 21 |

Label plastic box

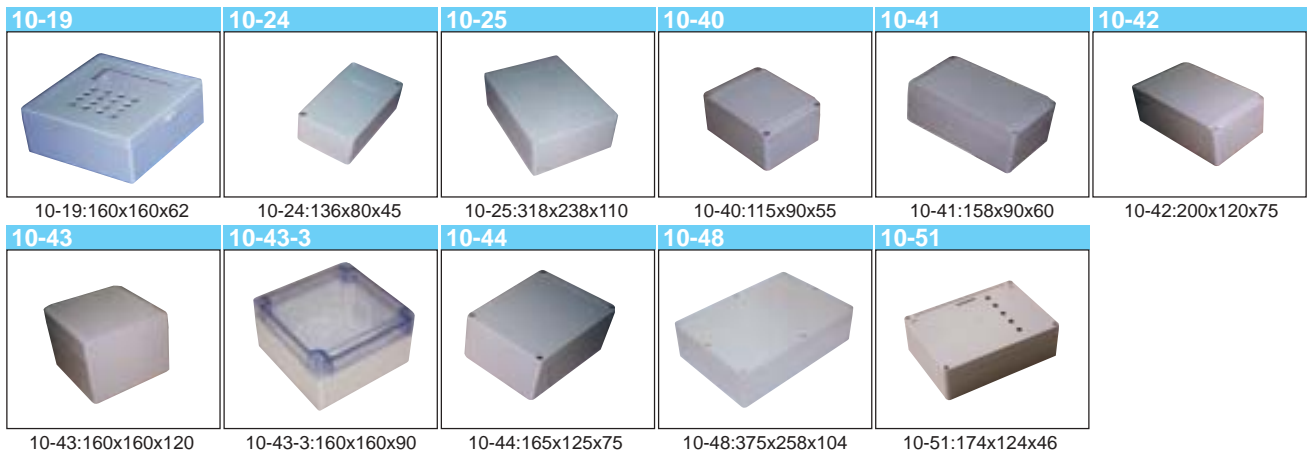

| Size | | | Indoor | | Outdoor | |
|-----------|----------|-----------|-----------|-----------|------------|------------|
| Length/mm | Width/mm | Height/mm | ABS | | PC(PC/ABS) | |
| | | | Solid lid | Clear lid | Solid lid | Clear lid |
| 160 | 160 | 62 | 10-19 | - | 10-19-PG | - |
| 136 | 80 | 45 | 10-24 | 10-24-1 | 10-24-PG | 10-24-1-PT |
| 318 | 238 | 110 | 10-25 | 10-25-1 | 10-25-PG | 10-25-1-PT |
| 115 | 90 | 55 | 10-40 | 10-40-1 | 10-40-PG | 10-40-1-PT |
| 158 | 90 | 60 | 10-41 | 10-41-1 | 10-41-PG | 10-41-1-PT |
| 200 | 120 | 75 | 10-42 | 10-42-1 | 10-42-PG | 10-42-1-PT |
| 160 | 160 | 120 | 10-43 | 10-43-1 | 10-43-PG | 10-43-1-PT |
| 160 | 160 | 90 | 10-43-2 | 10-43-3 | 10-43-2-PG | 10-43-3-PT |
| 165 | 125 | 75 | 10-44 | 10-44-1 | 10-44-PG | 10-44-1-PT |
| 375 | 258 | 104 | 10-48 | 10-48-1 | 10-48-PG | 10-48-1-PT |
| 174 | 124 | 46 | 10-51 | 10-51-1 | 10-51-PG | 10-51-1-PT |

Assembly drawing for label plastic box

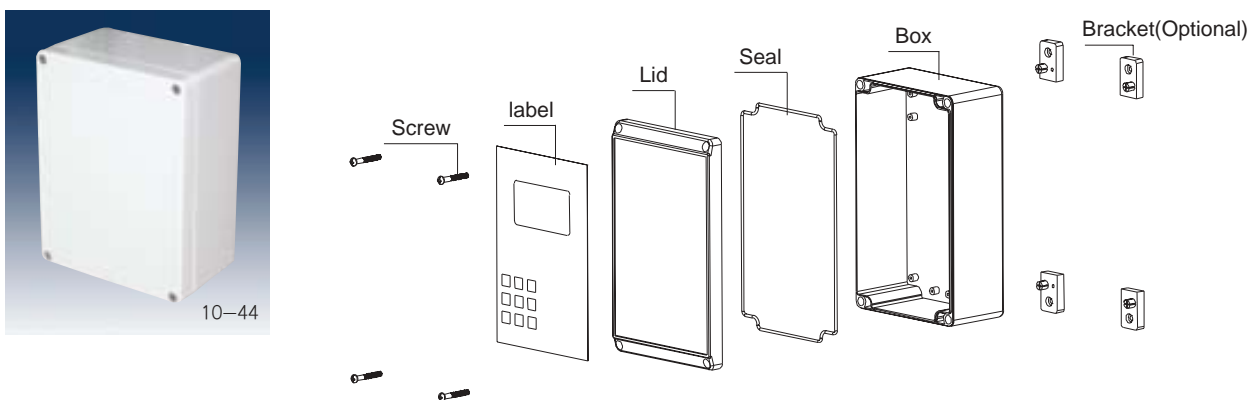





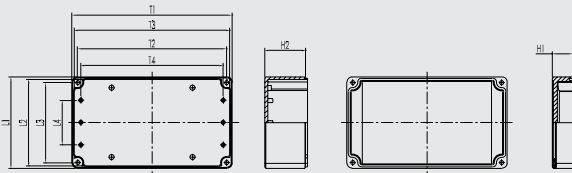

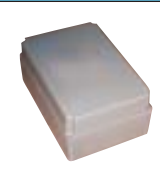

10 Sealed plastic enclosure

Unit:mm



| | T1 | T2 | T3 | T4 | L1 | L2 | L3 | L4 | H1 | H2 |
|---------|-----|-----|-----|-------|-----|-----|-----|------|----|----|
| 10-19 | 160 | 154 | - | - | 160 | 154 | - | - | 14 | 48 |
| 10-24 | 140 | 134 | 129 | 78 | 80 | 75 | 70 | 61 | 15 | 30 |
| 10-25 | 318 | 310 | 298 | 242 | 238 | 230 | 218 | 160 | 20 | 90 |
| 10-40 | 115 | 109 | 104 | 81 | 90 | 84 | 79 | 72 | 15 | 40 |
| 10-41 | 158 | 153 | 147 | 80 | 90 | 85 | 79 | 68.5 | 18 | 42 |
| 10-42 | 200 | 194 | 188 | 160 | 120 | 114 | 108 | 92 | 15 | 60 |
| 10-43 | 160 | 154 | 146 | 137.5 | 160 | 154 | 146 | 95 | 30 | 90 |
| 10-43-3 | 160 | 154 | 146 | 137.5 | 160 | 154 | 146 | 95 | 30 | 60 |
| 10-44 | 165 | 159 | 152 | 103.5 | 125 | 119 | 112 | 92 | 14 | 61 |
| 10-48 | 380 | 373 | 360 | 340 | 260 | 253 | 241 | 160 | 25 | 79 |
| 10-51 | 174 | 168 | 162 | 132 | 124 | 118 | 112 | 91 | 16 | 40 |

Label plastic box

| 10-33 | 10-50 | 10-52 | 10-53 | 10-54 | 10-55 |
|--|--|---|---|---|---|
|  |  |  |  |  |  |
| 10-33: 220x151x96 | 10-50: 245x186x100 | 10-52: 305x228x120 | 10-53: 245x195x98 | 10-54: 195x145x77 | 10-55: 155x115x75 |
| 10-33-1: Solid lid | 10-50-1: Solid lid | 10-52-1: Solid lid | 10-53-1: Solid lid | 10-54-1: Solid lid | 10-55-1: Solid lid |
| 10-56 | 10-57 | | | | |
|  |  | | | | |
| 10-56: 127x87x60 | 10-57: 110x110x60 | | | | |
| 10-56-1: Solid lid | 10-57-1: Solid lid | | | | |

| Size | | | Indoor | | Outdoor | |
|-----------|----------|-----------|-----------|-----------|------------|------------|
| Length/mm | Width/mm | Height/mm | ABS | | PC(PC/ABS) | |
| | | | Solid lid | Clear lid | Solid lid | Clear lid |
| 220 | 151 | 96 | 10-33 | 10-33-1 | 10-33-PG | 10-33-1-PT |
| 245 | 186 | 100 | 10-50 | 10-50-1 | 10-50-PG | 10-50-1-PT |
| 305 | 228 | 120 | 10-52 | 10-52-1 | 10-52-PG | 10-52-1-PT |
| 245 | 195 | 98 | 10-53 | 10-53-1 | 10-53-PG | 10-53-1-PT |
| 195 | 145 | 77 | 10-54 | 10-54-1 | 10-54-PG | 10-54-1-PT |
| 155 | 115 | 75 | 10-55 | 10-55-1 | 10-55-PG | 10-55-1-PT |
| 127 | 87 | 60 | 10-56 | 10-56-1 | 10-56-PG | 10-56-1-PT |
| 110 | 110 | 60 | 10-57 | 10-57-1 | 10-57-PG | 10-57-1-PT |

Assembly Drawing for plastic control box

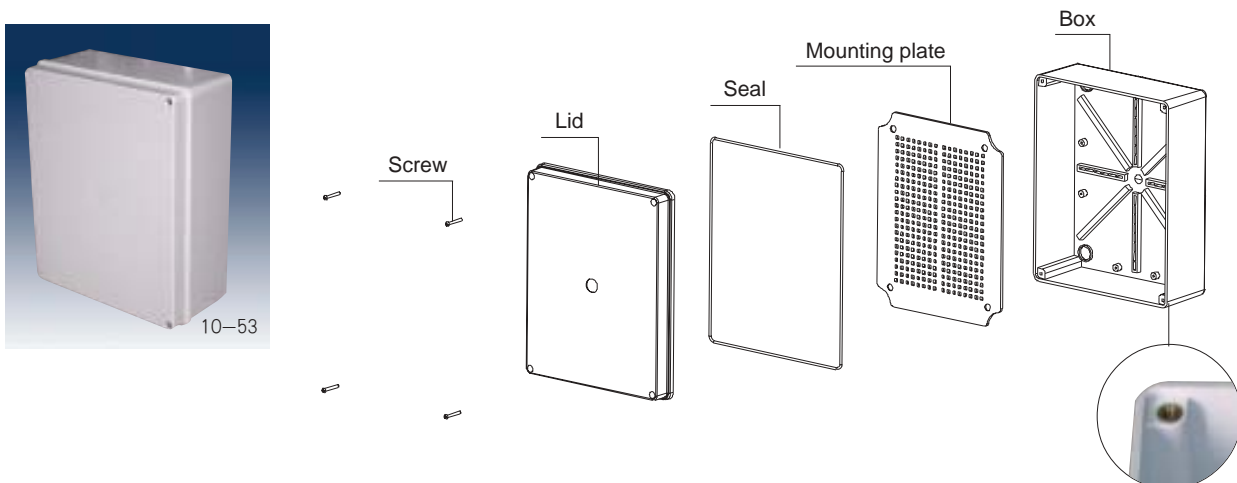

10 Sealed plastic enclosure

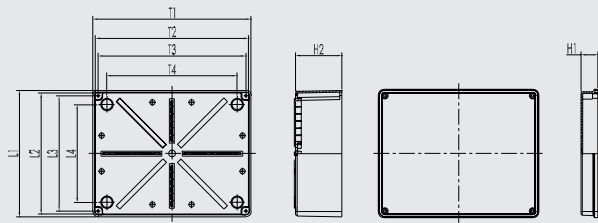

Unit, mm

| | T1 | T2 | T3 | T4 | L1 | L2 | L3 | L4 | H1 | H2 |
|-------|-----|-----|-----|------|-----|-------|-----|-----|------|------|
| 10-33 | 220 | 214 | 208 | 156 | 151 | 145 | 138 | 84 | 40 | 55 |
| 10-50 | 250 | 244 | 234 | 206 | 190 | 184 | 174 | 136 | 30 | 70 |
| 10-52 | 305 | 300 | 281 | 276 | 228 | 222 | 202 | 195 | 42 | 78 |
| 10-53 | 245 | 237 | 227 | 216 | 195 | 187 | 177 | 155 | 27 | 71 |
| 10-54 | 195 | 189 | 174 | 159 | 145 | 140 | 125 | 116 | 25 | 52 |
| 10-55 | 155 | 151 | 138 | 42.5 | 115 | 110.5 | 97 | 95 | 23 | 52 |
| 10-56 | 127 | 119 | 107 | 85 | 87 | 79 | 68 | 63 | 18 | 42 |
| 10-57 | 103 | 98 | 88 | - | 103 | 98 | 88 | - | 18.5 | 43.5 |

Other waterproof box

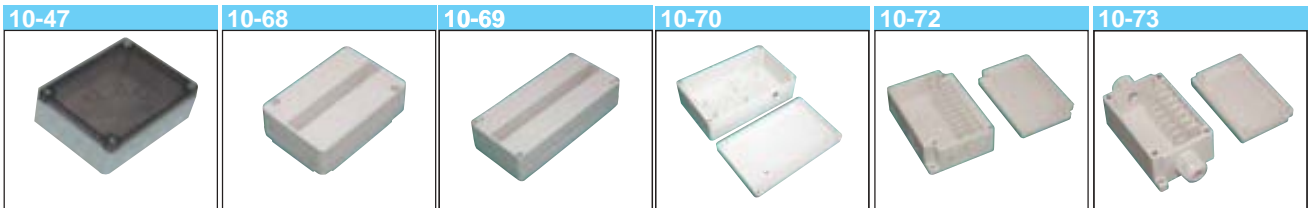

10-47:125x90x40

10-68:110x74x35

10-69:164x76x40

10-70:180x109x66

10-72:110x75x41

10-73:123x55x40

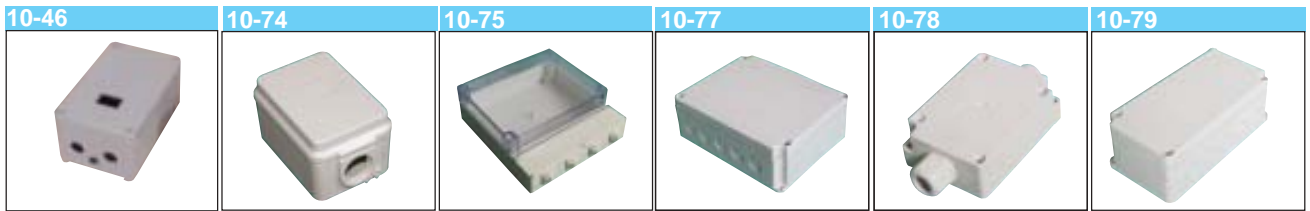

10-46:170x105x78

10-74:76x55x46

10-75:250x240x85

10-77:170x160x70

10-78:70x50x24

10-79:200x100x70



10-1-2:115x90x55

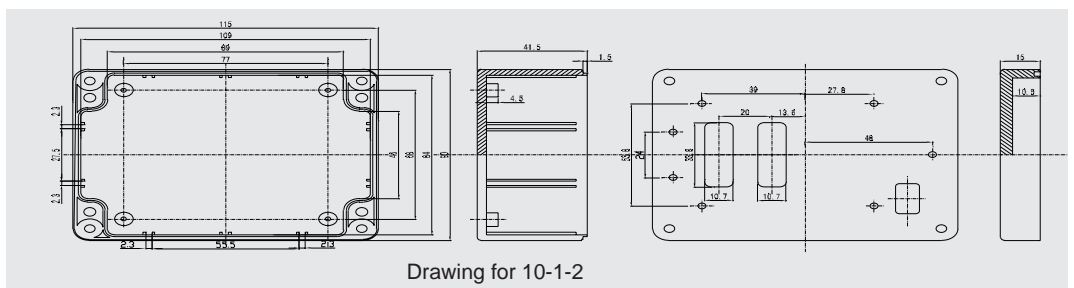

10-61:160x120x63

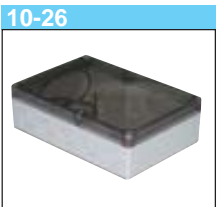
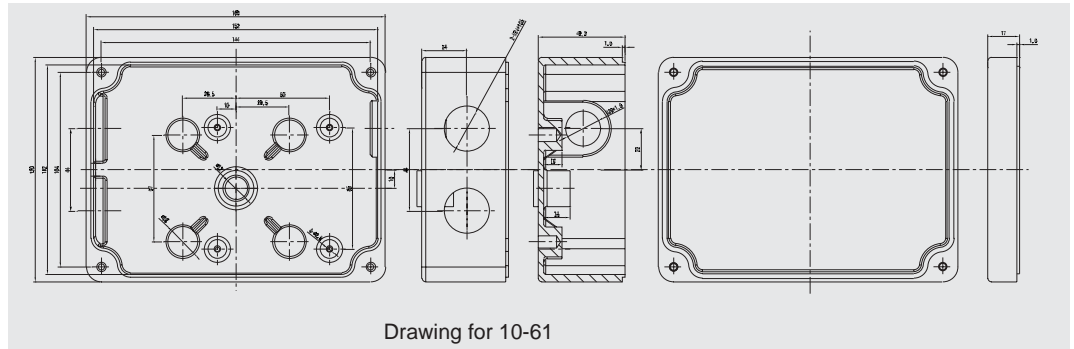

10-26:180x125x55

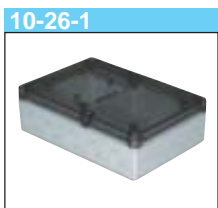

10-26-1:180x125x55

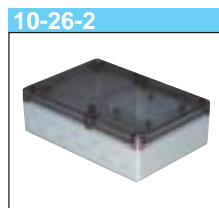

10-26-2:180x125x55

Mounting plate

